



LED-SL 33W

Model: SE _____

LIGHTING NETWORKS

Ordering Guide

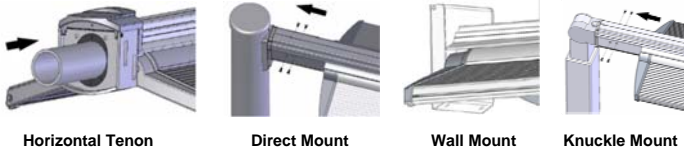
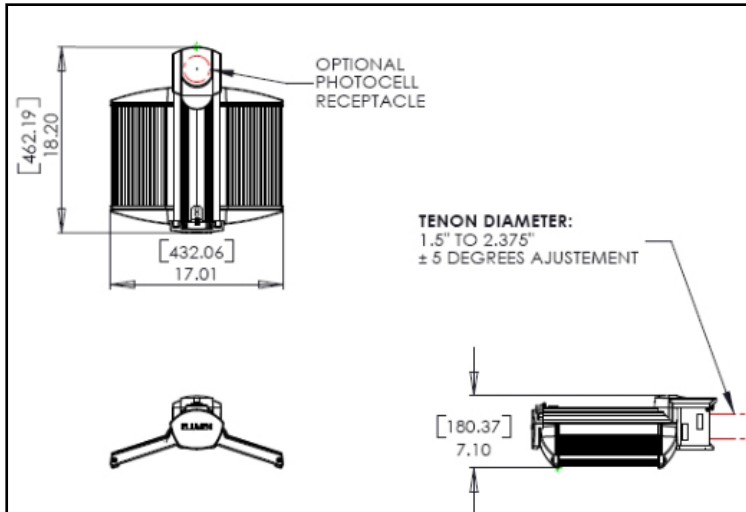

Example: SE G 33 C3 TMN 5A

Product Code	SE	Streetlight Elumen
Color	K	BLACK
	B	DARK BROWN
	G	GREY
SIZE	33	36W
LEDS	C3	5000K White LEDs (low voltage array) type 2 to 3 distribution *
MOUNTING	TM	Horizontal Tenon Mount 1.5" to 2 3/8" (38mm to 59mm)
	DM	Direct Mount Square Pole
	DR	Direct Mount Round Pole
	WM	Wall Mount
	KM	Knuckle Mount
PHOTO RECEPTACLE	N	None
	R	Twist-Lock Receptacle**
WING ANGLE	1	degree (spacing up to 4 MH)
	2	4.5 deg (spacing up to 4.5 MH)
	3	9 deg (spacing up to 5MH)
	4	13.5 deg (spacing up to 6 MH)
	5	18 deg (spacing up to 7 MH)
	6	22.5 deg (spacing up to 7.5 MH)
LED DRIVER	A	85-300VAC
	AM	85-300VAC w Midnight Dimming (50% from 11h30PM to 5h30AM)
	AS	85-300VAC w Motion Sensor (50% no motion, 100% when motion)

* Type depends on wing angle. See cut sheet for more details
 ** No photocell receptacle on Wall Mount models.

Product Specifications

LED Light: 36W initial consumption, 2489 delivered and maintained lumens, 90,000 hrs without lumen depreciation (LLF>95%), CRI>80.

LED ARRAYS: 720 5mm low power, lighting grade LEDs arranged in a series/parallel matrix for optimal reliability and heat dissipation. Each led uses less than 1/10th of a watt each and is precision aimed for optimal photometric performance. Separate panel assemblies (wings) can be field adjusted to 6 different beam patterns to achieve desired spacing requirements.

LED DRIVER: Elumen Lighting Networks **OptiACtm** auto-ranging 85-300Vac, 50-60Hz input, 0.98 Power factor and THD<10%. Standard aging compensation algorithm insures long led life and uniform intensity for 21 years (end of life power consumption will be 30% more than initial). Temperature compensation, temperature protection and lightning protection are built-in. **OPTIONS:** Automatic Midnight dimming to 50% from 11h30PM to 5h30AM or Motion sensor inputs for 50% /100% operation upon presence or absence of AC signal from an external sensor (not provided).

HOUSING: Aluminum extrusions and castings finished with a super durable, electrostatically applied thermoset polyester powdercoat applied after a 5 stage conversion cleaning process and bonded by heat fusion thermosetting. Laboratory tested for superior weatherability and fade resistance in accordance with ASTM B-117-64 and ANSI/ASTM G53-77 specifications. High Impact Acrylic Lens is sealed to housing (IP66 protection).

ENVIRONMENTAL: -60 °C to 45 °C operating temperature. Vibration tested as per ANSI C136.31-2001 for bridges.

CERTIFICATIONS: CSA Listed to U.S. Safety Standards UL1598 and CSA C22.2 No. 250.0-08 for wet locations. Manufactured to ISO 9001:2000 Standards. RoHS.

WARRANTY: 5 year limited warranty

IESNA Classifications: Full Cut-Off at 0 degrees wing angle.

DIMENSIONS (W x H x L) : 15.75" x 7.0" x 17.1" (400mm x 178mm x 434mm)

EPA: 0.8 sq. ft.

WEIGHT: 13.3 lbs (6,0 Kg)

PATENT PENDING



OptiACtm

Elumen Lighting Networks reserves the right to modify the above details to reflect



LED-SL 33W

Model: SE _____

LIGHTING NETWORKS

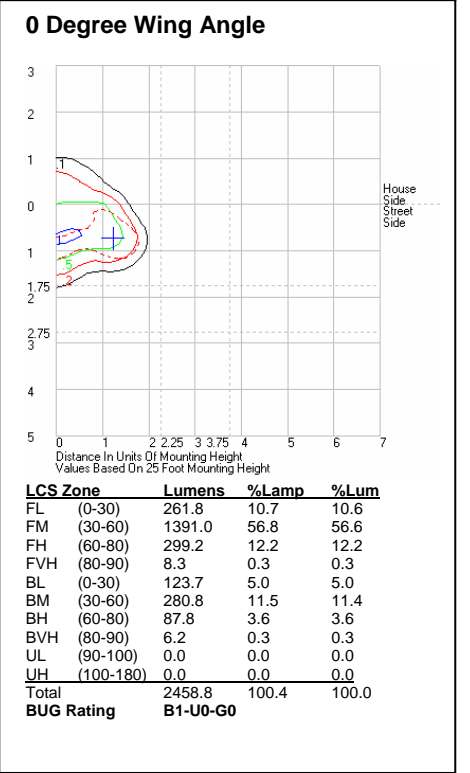
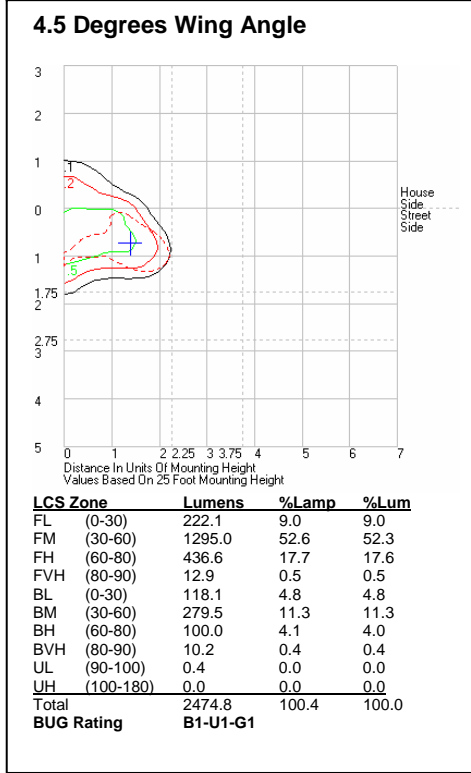
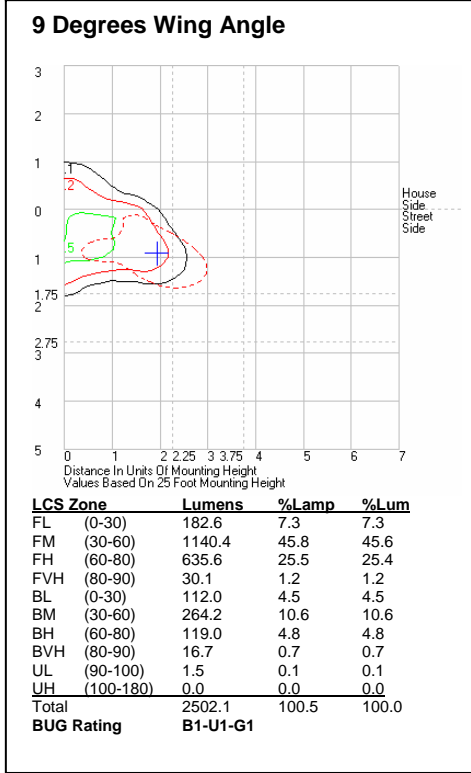
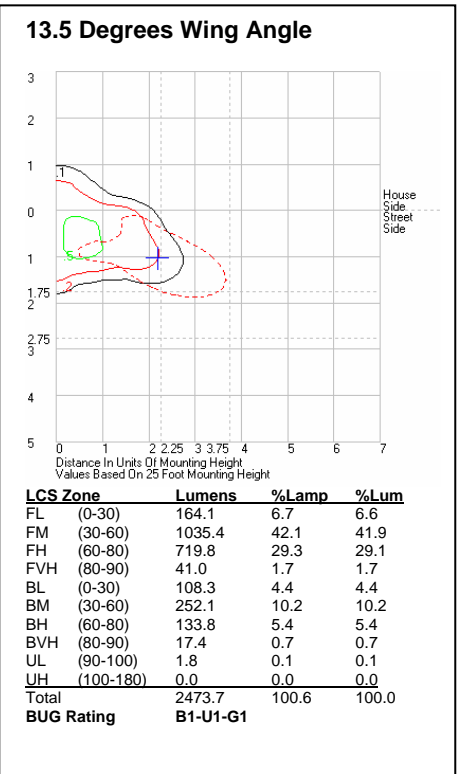
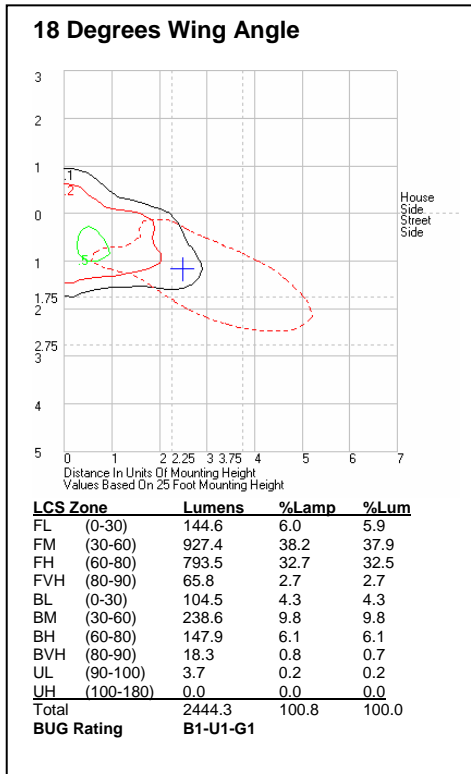
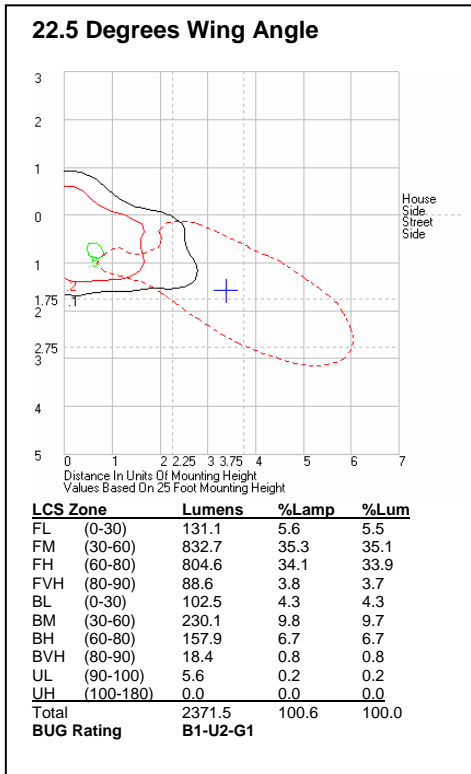

+Data Sheet +Cut Sheet +Installation Instructions + LM-79 IES Files & data +Product Shots +Motion Sensor Installation and operation



GREENLIGHT INITIATIVE – New York, NY - Ph: (718) 784-4440 - Fax: (718) 228-8202 – Toll Free: 888-788-LEDS (5337) Sales@lednyc.com – info@lednyc.com - www.LEDnyc.com